

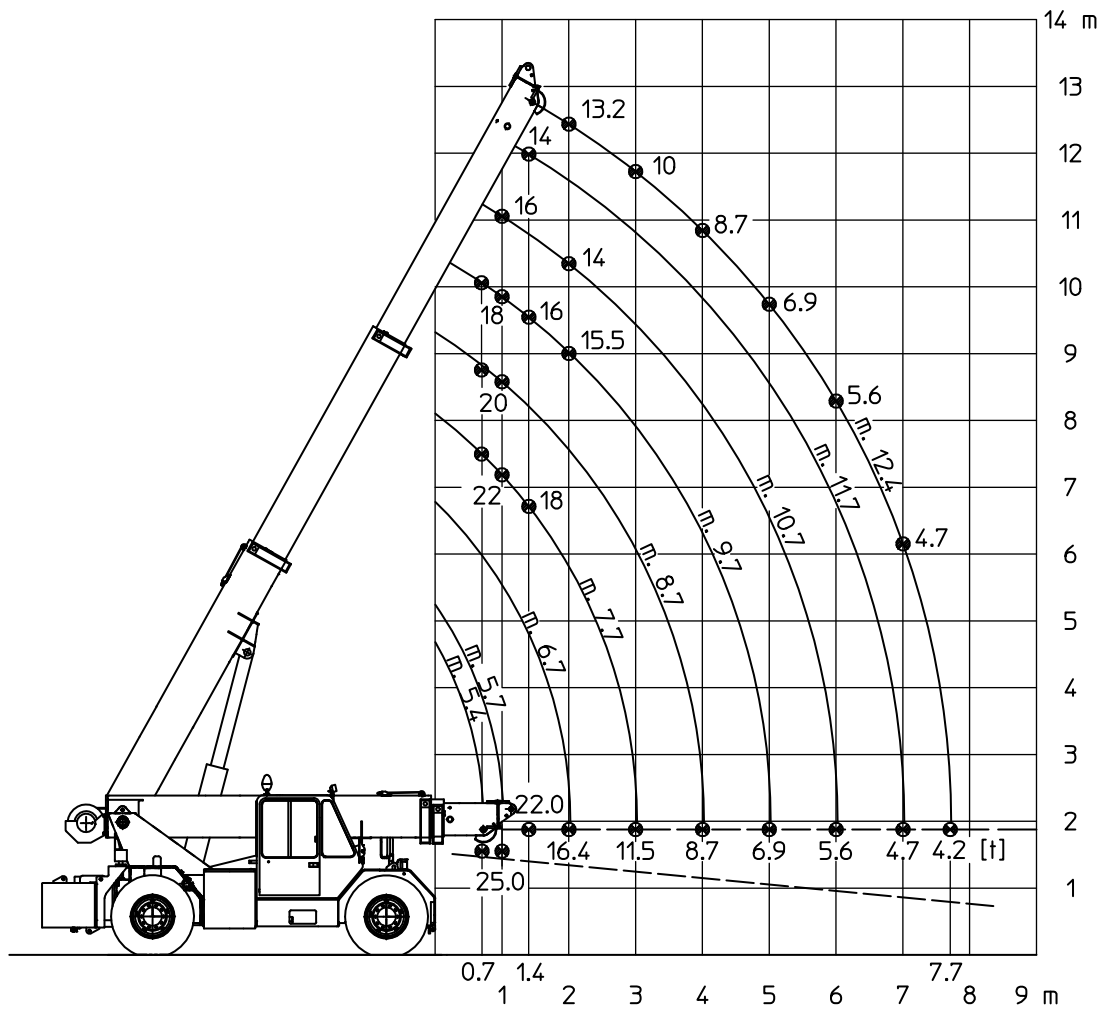

ORMIG 25tmE



INFO: mktg@ormigspa.com